

HIGHER[®]
PROFESJONALNI NA KAŻDYM SZCZEBLU







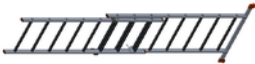
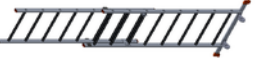

RUSZTOWANIE ALUMINIOWE HIGHER VELLY

INSTRUKCJA MONTAŻU

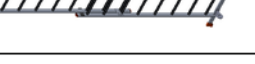

HIGHER MONIKA GODLEWSKA
ul. Armii Krajowej 74, 58-130 Żarów
www.sklep.drabiny.info

7507-7511 - SPIS ELEMENTÓW

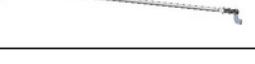
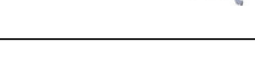
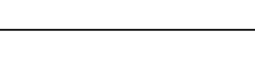
NO	ZDJĘCIE / PHOTO	NAZWA	MATERIAL NAME	WAGA / WEIGHT KG	7507- V	7508- V	7509- V	7511- V
1		DRABINA 2x7	2X7 LADDER	10,5	1	-	-	-
2		DRABINA 2x7 + KOŁA	2X7 STAIRCASE WITH WHEELS	11,4	1	-	-	-
3		DRABINA 2x8	2X8 LADDER	12	-	1	-	-
4		DRABINA 2x8 + KOŁA	2X8 STAIRCASE WITH WHEELS	12,9	-	1	-	-
7		DRABINA 2x9	2X9 LADDER	13,5	-	-	1	-
8		DRABINA 2x9 + KOŁA	2X9 STAIRCASE WITH WHEELS	14,4	-	-	1	-
9		DRABINA 2x11	2X11 LADDER	15	-	-	-	1
10		DRABINA 2x11 + KOŁA	2X11 STAIRCASE WITH WHEELS	15,9	-	-	-	1
11		PLATFORM 172	PLATFORM 172	8,65	1	1	1	1
13		GÓRNA PORĘCZ	TOP SLAT	1,23	6	6	6	6
14		DOLNA PORĘCZ	LOWER SLAT	1,32	2	2	2	2
15		STĘŻENIE WEWNĘTRZNE	INNER CROSS	1,36	2	2	2	2
16		STĘŻENIE ZEWNĘTRZNE	OUTER CROSS	1,45	2	2	2	2
		WAGA CAŁKOWITA	TOTAL WEIGHT		47,5	50,5	53,5	56,5

INSTRUKCJA MONTAŻU W KILKU KROKACH

1

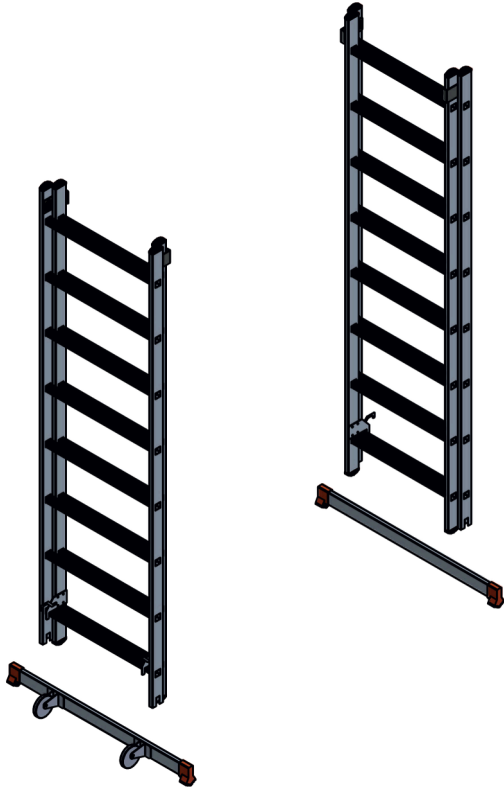

2

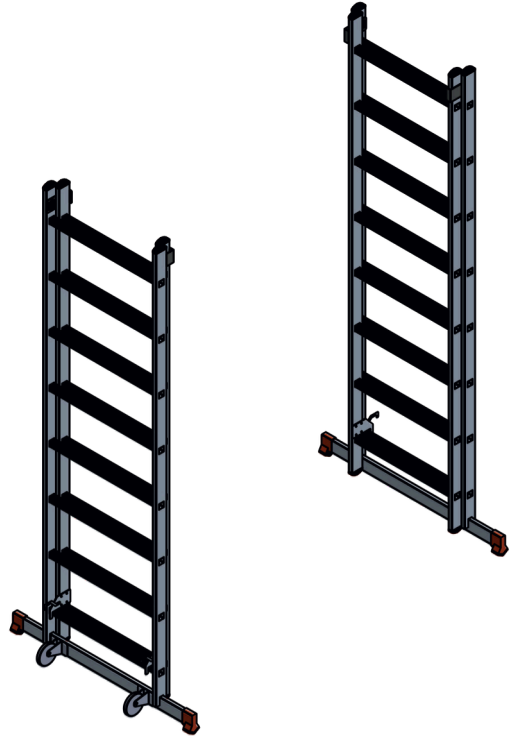

3

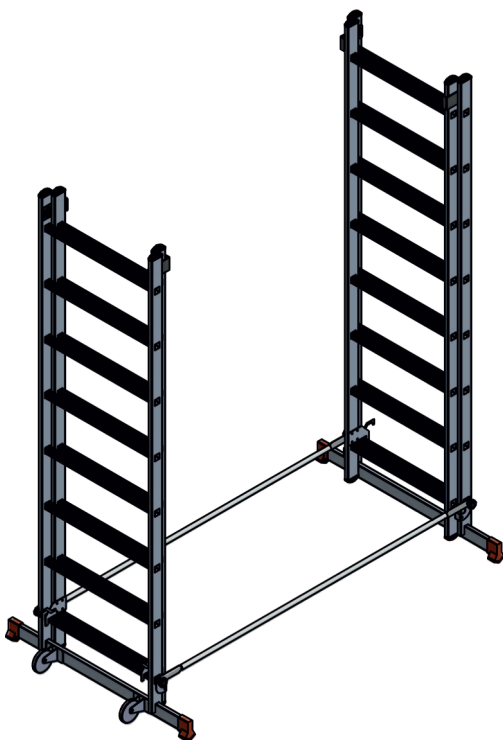

4

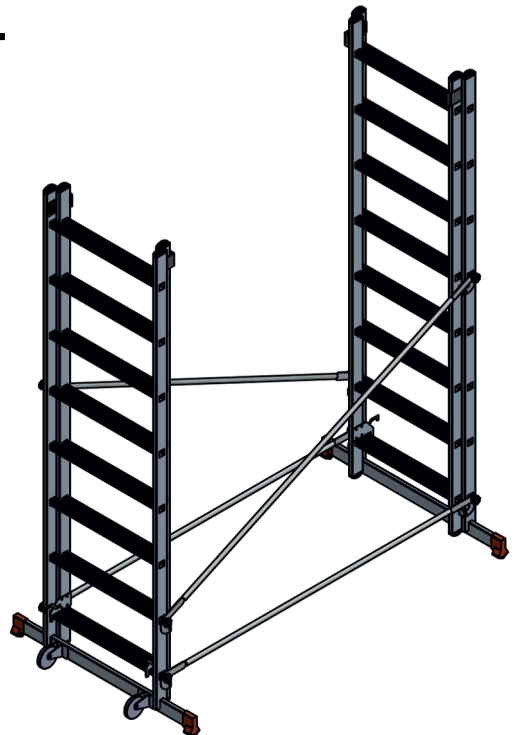

5

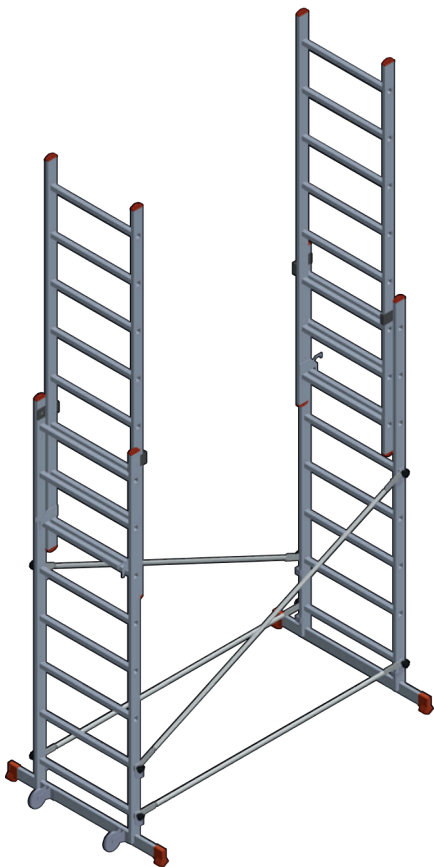

6

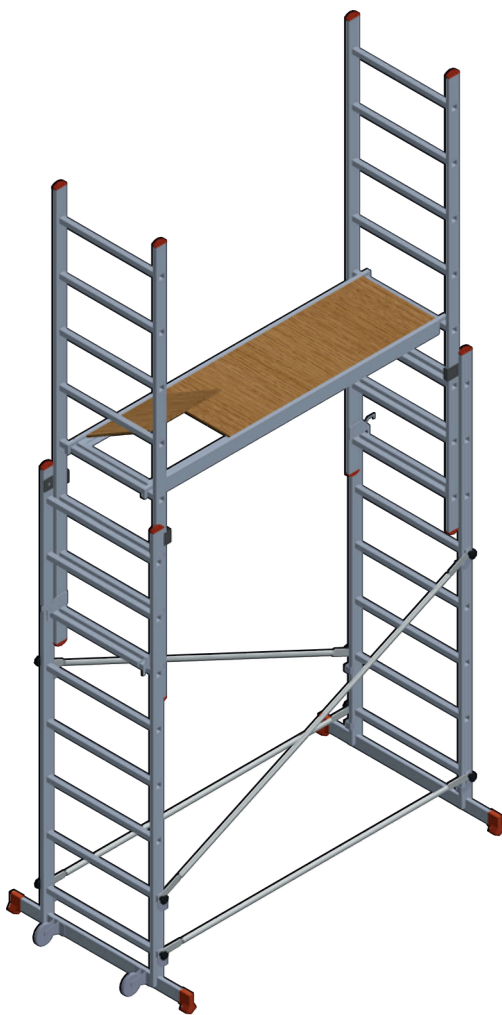

7

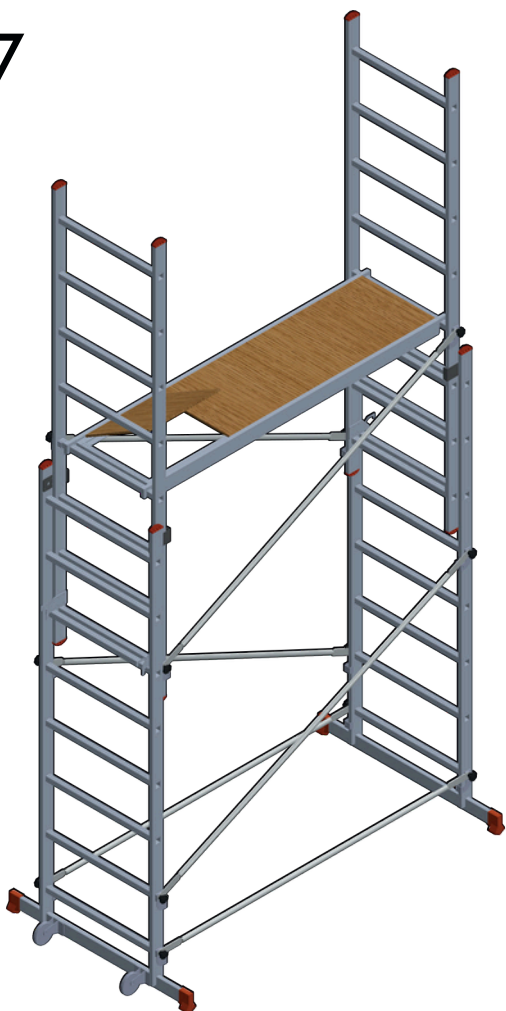

8

