

DRABINY / LADDER

| MODEL / MODEL | DRABINY / LADDERS | ILOŚĆ / PCS |
|---------------|-------------------|-------------|
| 7507 | 2x7 | 2 |
| 7509 | 2x9 | 2 |
| 7511 | 2x11 | 2 |
| 7513 | 2x13 | 2 |
| 7515 | 2x15 | 2 |

CECHY PRODUKTU / PRODUCT FEATURES

| MODEL / MODEL | WYSOKOŚĆ DRABIN (mm) / LADDERS HEIGHT (mm) | WYMIARY PODESTU (mm) / PLATFORM DIMENSIONS (mm) |
|---------------|--|---|
| 7507 | 2053 | 1900 x 500 |
| 7509 | 3133 | 1900 x 500 |
| 7511 | 4213 | 1900 x 500 |
| 7513 | 5023 | 1900 x 500 |
| 7515 | 6103 | 1900 x 500 |
| 7519 | 8263 | 1900 x 500 |

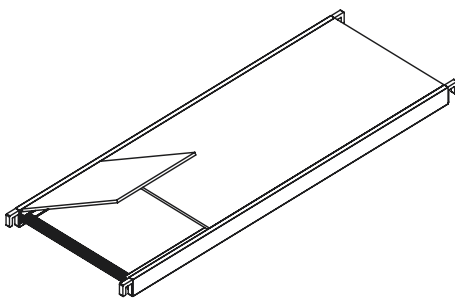

PODEST / PLATFORM

| MODEL / MODEL | SZT. / PCS. |
|---------------|-------------|
| 7507 | 1 |
| 7509 | 1 |
| 7511 | 1 |
| 7513 | 2 |
| 7515 | 2 |
| 7519 | 2 |

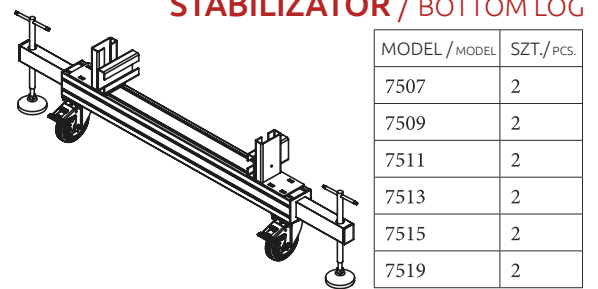

STABILIZATOR / BOTTOM LOG

| MODEL / MODEL | SZT. / PCS. |
|---------------|-------------|
| 7507 | 2 |
| 7509 | 2 |
| 7511 | 2 |
| 7513 | 2 |
| 7515 | 2 |
| 7519 | 2 |

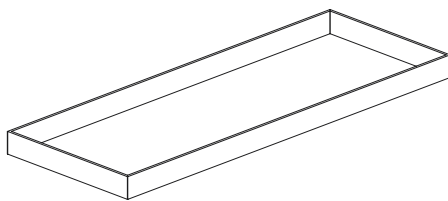

BURTY / TOEBOARD

| MODEL / MODEL | SZT. / PCS. |
|---------------|-------------|
| 7507 | 1 |
| 7509 | 1 |
| 7511 | 1 |
| 7513 | 1 |
| 7515 | 1 |
| 7519 | 1 |

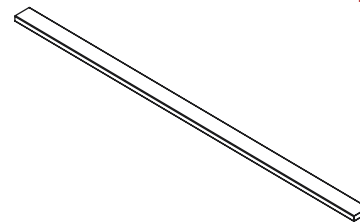

PROFIL / PROFILE

| MODEL / MODEL | SZT. / PCS. |
|---------------|-------------|
| 7507 | 2 |
| 7509 | 2 |
| 7511 | 2 |
| 7513 | 2 |
| 7515 | 2 |
| 7519 | 2 |

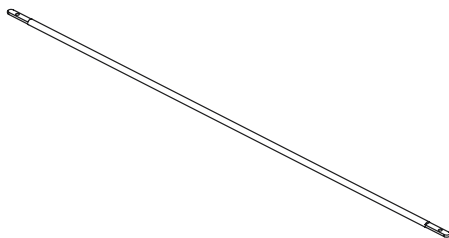

STĘŻENIA / DIAGONAL

| MODEL / MODEL | DŁUGOŚĆ / HEIGHT | SZT. / PCS. |
|---------------|------------------|-------------|
| 7507 | 242 cm | 2 |
| | 187,5 cm | 2 |
| | 168 cm | 6 |
| 7509 | 281 cm | 2 |
| | 216,5 cm | 2 |
| | 168 cm | 6 |
| 7511 | 324 cm | 2 |
| | 254,5 cm | 2 |
| | 168 cm | 6 |
| 7513 | 371 cm | 2 |
| | 296,5 cm | 2 |
| | 168 cm | 8 |
| 7515 | 419,5 cm | 2 |
| | 343,5 cm | 2 |
| | 168 cm | 8 |
| 7519 | 518 cm | 2 |
| | 440 cm | 2 |
| | 168 cm | 8 |

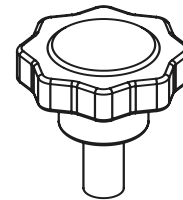

POKRĘTŁO / KNOB

| MODEL / MODEL | SZT. / PCS. |
|---------------|-------------|
| 7507 | 16 |
| 7509 | 16 |
| 7511 | 16 |
| 7513 | 20 |
| 7515 | 20 |
| 7519 | 20 |

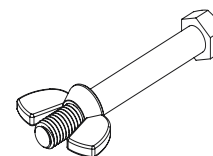

NAKRĘTKA / NUT SCREW

| MODEL / MODEL | SZT. / PCS. |
|---------------|-------------|
| 7507 | 4 |
| 7509 | 4 |
| 7511 | 4 |
| 7513 | 4 |
| 7515 | 4 |
| 7519 | 4 |

Rusztowanie HIGHER seria 75PRO - instrukcja montażu

Aluminium mega scaffolding installation manual

HIGHER[®]
PROFESJONALNI NA KAŻDYM SZCZEBLU

RYSUNEK 01 / FIG. 01

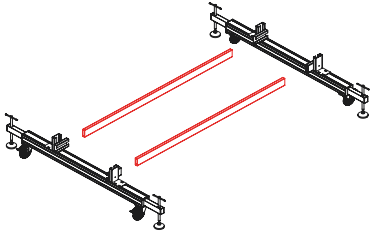

Umieść 2 profile poziomo w gniazdach stabilizatorów.

Insert 2 intermediate profiles into their sockets.

RYSUNEK 02 / FIG. 02

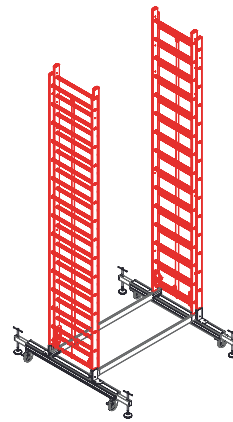

Umieść 2 wstępnie zmontowane drabinki, w gniazdach stabilizatorów. Upewnij się, że drabiny zamontowane są równoległe.

Place the 2 pre-assembled ladders that come out of the package, into their slots. Make sure that narrower sized ladders are facing each other.

RYSUNEK 03 / FIG. 03

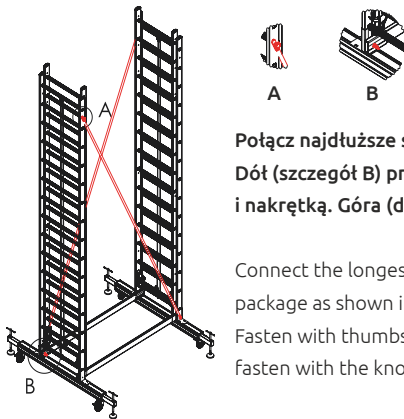

Połącz najdłuższe stężenia, jak pokazano na rysunku. Dół (szczegół B) przymocuj śrubą radetkowaną i nakrętką. Góra (detal A) śruba zakończona gatką.

Connect the longest laths that come out of the package as shown in the picture. Bottom (detail B) Fasten with thumbscrew and nut. Top (detail A) Fasten with the knob.

RYSUNEK 04 / FIG. 04

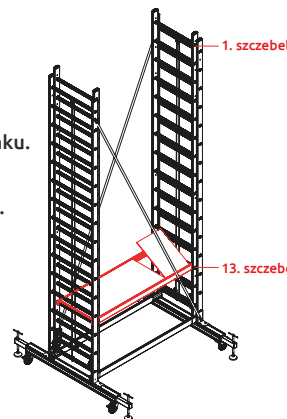

Dotyczy rusztowań z 2 podestami. Drugi podest zawsze umieszczamy na 13 szczepku od góry!

Applies to products with 2 platforms. Step rank to fix the platform.

RYSUNEK 05 / FIG. 05

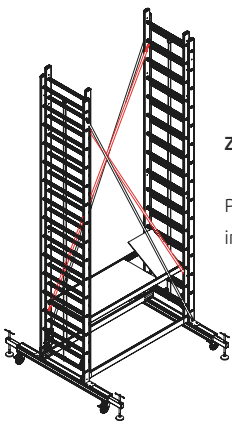

Zamocuj stężenia ukośne zgodnie z rysunkiem.

Place the diagonal with the knobs as shown in the picture.

RYSUNEK 06 / FIG. 06

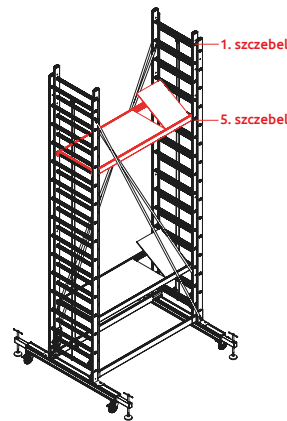

Dotyczy wszystkich rusztowań z serii! Umieść podest na 5 szczepku od góry.

Valid for all the series. Place the platform at 5th rung from the top.

RYSUNEK 07 / FIG. 07

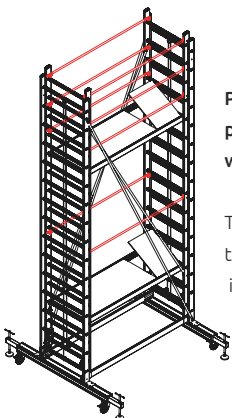

Po prawej i lewej stronie górnej platformy zamontuj po 3 poręcze. Dolne poręcze są dostępne tylko w modelach 7513-7515.

There are 3 laths each on the right and left for the upper platform. The lower bar is only available in 7513-7515.

RYSUNEK 08 / FIG. 08

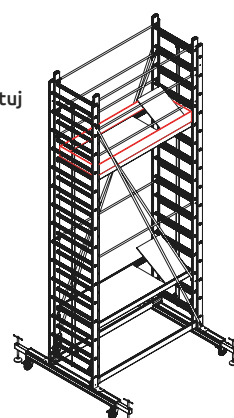

Zamocuj burty zgodnie z rysunkiem nr. 08.

Place toeboard as shown in the fig. 08.